



START HERE!

READ ME FIRST

Don't be a hero and muscle through this without first reading these fitting instructions! Improper installation of this gear may void certain aspects of your warranty.

Before you begin, take a moment and open all your Front Runner rack kit boxes and gather the assembly instructions for the various components.

A complete kit will contain:

1. A Front Runner Mounting System specific to your vehicle
2. A Front Runner Rack Tray or Load Bar Slats

This document will guide you through the assembly of the mounting system and assist you in fitting the roof rack tray or load bars to your specific vehicle.

Please refer to the next page for a list of all the components, quantities and tools required.

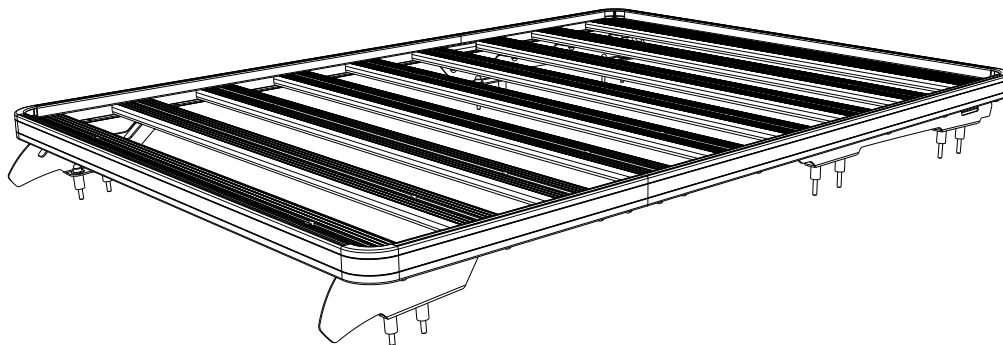

Front Runner will not be responsible for any damage caused by the failure to install the product according to these instructions. Please call us if you have any questions about the installation of this product.

IMPORTANT WARNING!

FRONT RUNNER CAN NOT RECOMMEND A MAXIMUM LOAD CARRYING CAPACITY. PLEASE REFER TO YOUR VEHICLE MANUFACTURER'S RECOMMENDATIONS. IT IS CRITICAL THAT ALL FRONT RUNNER PRODUCTS BE PROPERLY AND SECURELY ASSEMBLED AND ATTACHED TO YOUR VEHICLE. IMPROPER ATTACHMENT COULD RESULT IN AN AUTOMOBILE ACCIDENT, AND COULD CAUSE SERIOUS BODILY INJURY OR DEATH. YOU ARE RESPONSIBLE FOR ASSEMBLING AND SECURING ALL FRONT RUNNER PRODUCTS TO YOUR VEHICLE. CHECKING THE ATTACHMENTS PRIOR TO USE, AND PERIODICALLY INSPECTING THE PRODUCTS FOR ADJUSTMENT, WEAR AND DAMAGE. THEREFORE YOU MUST READ AND UNDERSTAND ALL OF THE INSTRUCTIONS AND PRECAUTIONS SUPPLIED WITH YOUR FRONT RUNNER PRODUCT PRIOR TO INSTALLATION OR USE. IF YOU DO NOT UNDERSTAND ALL OF THE INSTRUCTIONS AND CAUTIONS, OR IF YOU HAVE NO MECHANICAL EXPERIENCE AND ARE NOT THOROUGHLY FAMILIAR WITH THE INSTALLATION PROCEDURES, YOU SHOULD HAVE THE PRODUCT INSTALLED BY A PROFESSIONAL INSTALLER OR OTHER QUALIFIED PERSONNEL.

1

GET ORGANIZED

IN THE BOX

1	2 X	Front Foot Rail; 1LH + 1RH
2	2 X	Rear Foot Rail; 1LH + 1RH
3	24 X	M8 Nut Cap
4	4 X	M8 x 60 Hex Bolt
5	12 X	M8 SS Spring Washer
6	12 X	M8 x 25 x 2 Flat Washer
7	12 X	M8 x 20 Hex Bolt
8	12 X	M8 16 x 1.6SS Flat Washer
9	12 X	M8 Nyloc Nut
10	12 X	Spacer 19 x 30mm
11	8 X	M8 x 70 Hex Bolt

TOOLS NEEDED

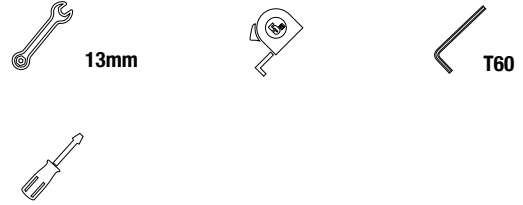
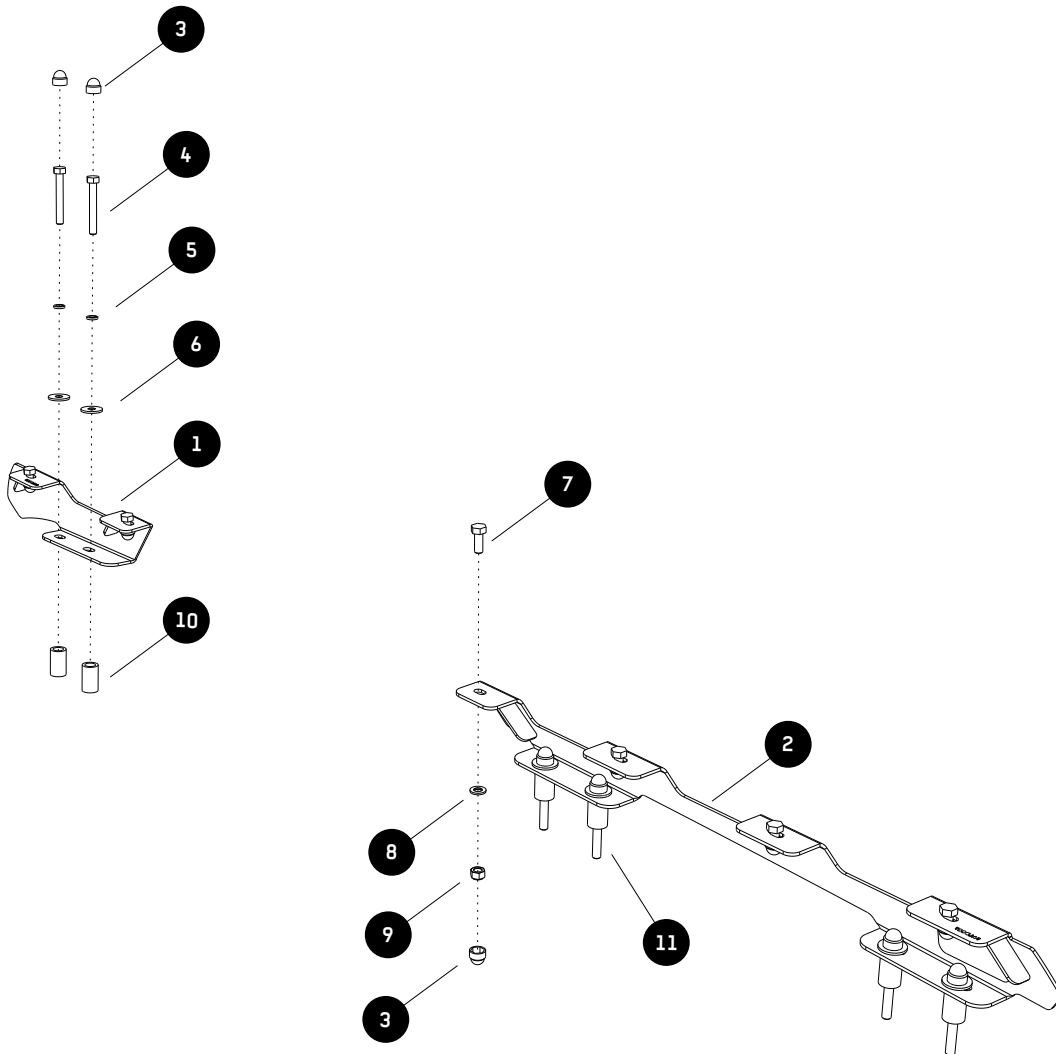

FIGURE 1.1



2 FIT AND SECURE

2.1



Before starting the fitment you need to remove the front, middle and rear Ditch Covers from the vehicle's roof.
Loosen the bolts holding the rail in place.
Do this on both sides of the vehicle.

2.2

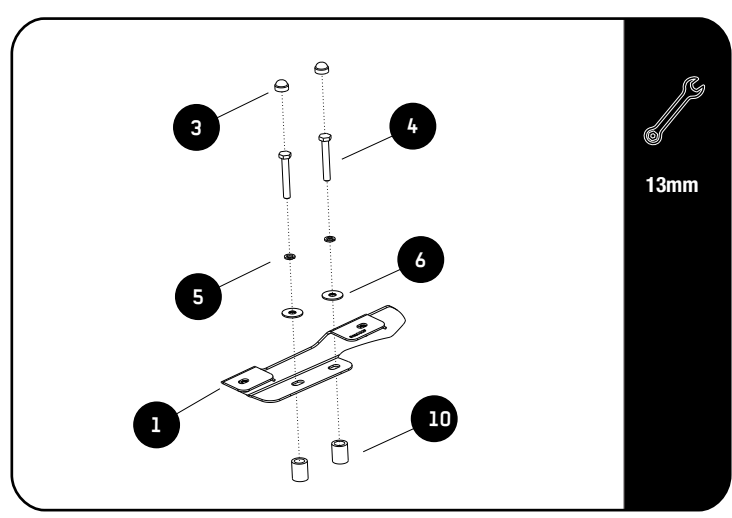

Place Spacers (Item 10) over each of the holes where you have removed the bolts.
Secure the Front Foot Rail (Item 1) to the vehicle using M8 x 60 Hex Bolts, M8 SS Spring Washers and M8 x 25 x 2 Flat Washers (Items 4, 5 & 6) as shown.
Finish of by placing M8 Nut Caps (Item 3) on the bolt heads.
Repeat this on both sides of the vehicle.

2.3

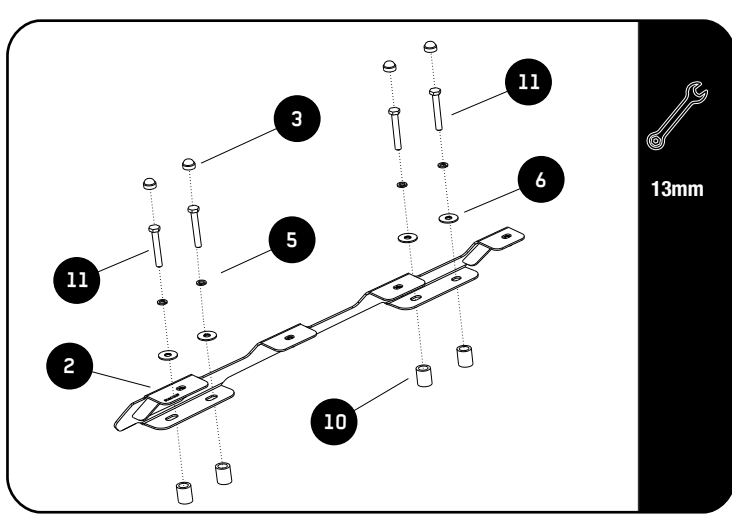

Secure the Rear Foot Rail (Item 2) to the vehicle using M8 x 70 Hex Bolts, M8 SS Spring Washers and M8 x 25 x 2 Flat Washers (Items 11, 5 & 6) as shown.
Finish of by placing M8 Nut Caps (Item 3) on the bolt heads.
Repeat this on both sides of the vehicle.

3**FIT AND SECURE****3.1**

Refer to RRSUNI when assembling your Slimline II Tray.

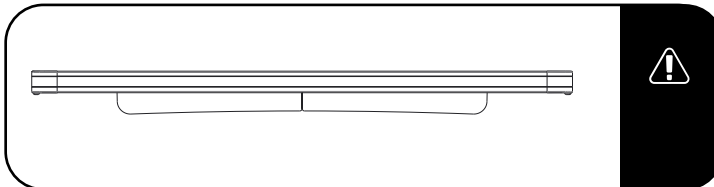
**3.2**

Make sure that the wind deflector is installed before you proceed to the next step.

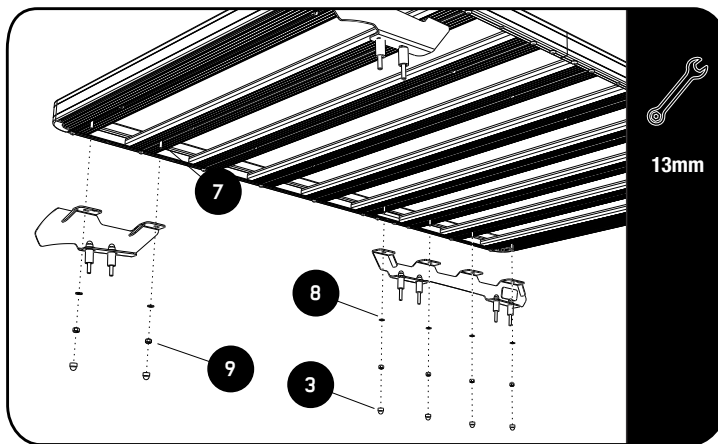
3.3

13mm



Fit your roof rack to the Foot Rails using M8 x 20 Hex Bolts, M8 x 16 x 1.6SS Flat Washers and M8 Nyloc Nuts (Items 7, 8 & 9).

3.4

Center the rack and tighten fully. Use M8 nut caps (Items 3) to finish off the nuts.



4

COMPLETION

4.1



Congratulations! You did it. Take a step back and admire your work!

6

INSTALL OTHER VEHICLE AND RACK ACCESSORIES

Now's the time to visit your favorite Front Runner Dealer in person or online.

Be sure to tag us. We love to see our gear in action! #FrontRunnerOutfitters #BornToRoam

Share your adventures on: 