

2

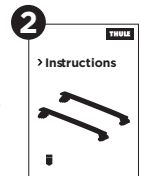

> Instructions

Thule Evo Flush Rail
710600

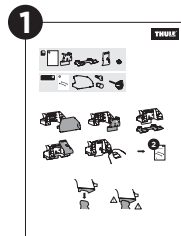
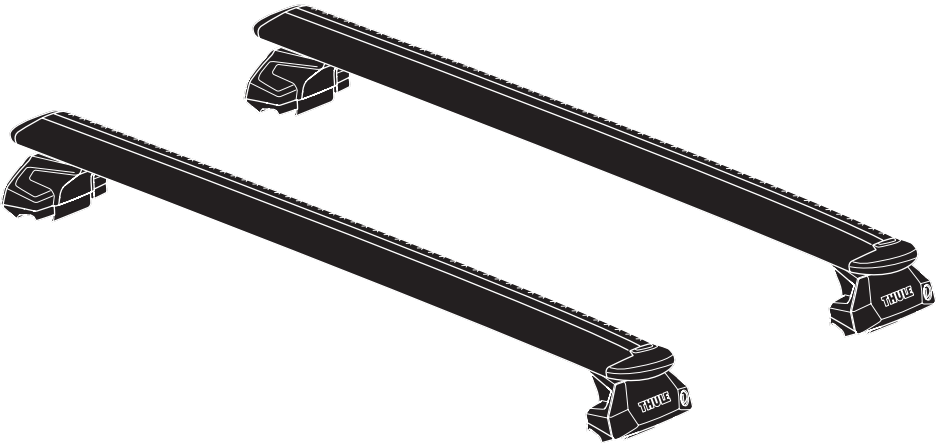

THULE.COM

EN Roof mounted load carrier
DE Lastenträger zur Dachmontage
FR Barre de toit
NL Dakdrager
IT Barra portatutto da installare sul tetto
ES Portaequipajes de techo
PT Barra para montagem no tejadilho
SV Takmonterad lasthållare
DK Tagmonteret lastholder
NO Takmontert lasteholder
FI Katolle asennettava teline
ET Katusele paigaldatav katuseraam
LV Uz jumta uzstādāms kravas turētājs
LT Ant stogo tvirtinamas krovinijų laikiklis
PL Uchwyty na bagażnik bazowy montowany na dachu
RU Багажник на крышу
UK Багажник для даху
BG Багажник, монтиран върху покрива
CS Nosič pro montáž na střechu
SK Strešný nosič
SL Nosilec za strešni prtljajnik
HR/BIH Krovni nosač tereta

RO Suport încarcătură montat pe acoperiș
HU Tetőre szerelhető csomagszállító
EL Σχάρα οροφής για μεταφορά φορτίου
TR Araç üstüne bağlanan yük taşıyıcı

HE מנשא מטען לגג הרכב
AR حامل نقل مثبت على السقف
ZH 顶置行李架
JA ルーフマウント型ロードキャリア
KO 루프 장착 화물 캐리어
TH โครงยึดของบรรทุกแบบติดตั้งบนหลังคา

CITY CRASH
Complies with ISO norm

ISO 11154-E

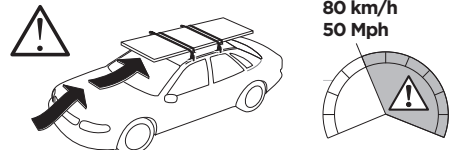
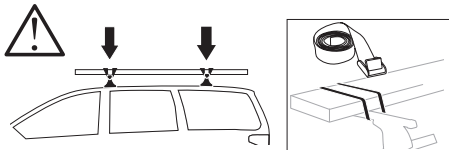
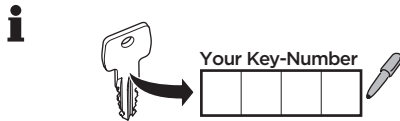
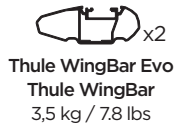
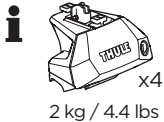
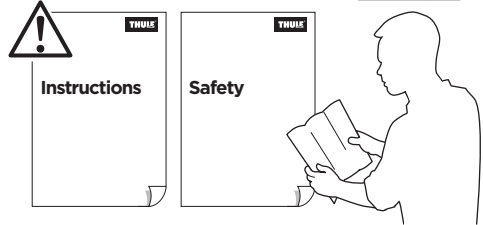

> Mounting Tutorial
Thule Evo Flush Rail



1
KIT

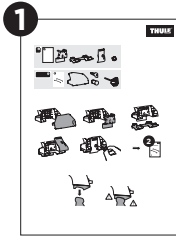

2
FOOT PACK

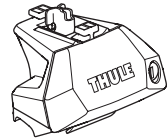
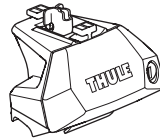
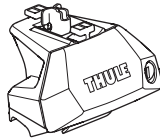
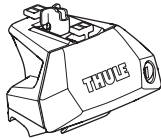
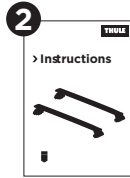

3
BAR

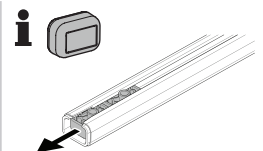
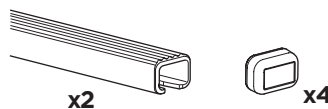
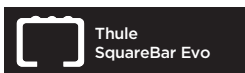
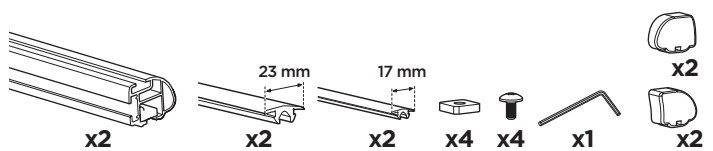
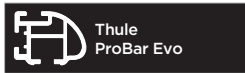
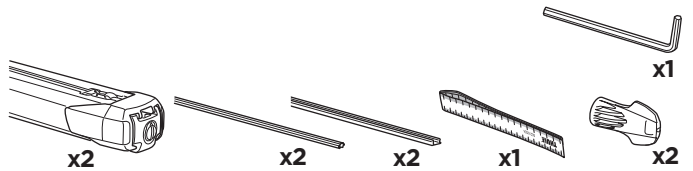
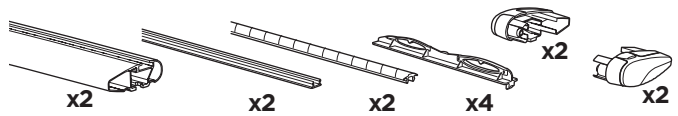
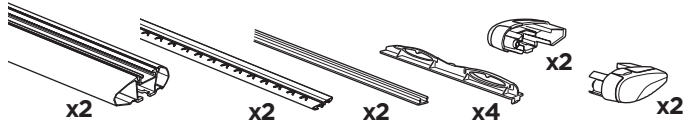

1

BAR

3



Thule
WingBar Evo

A

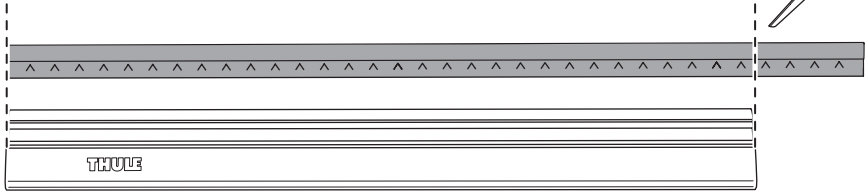

B

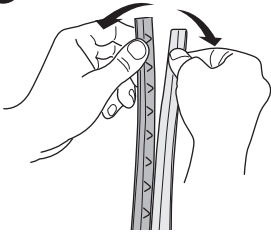

C

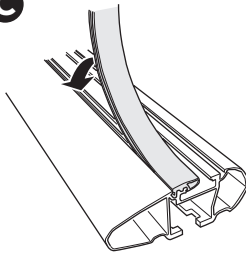

D

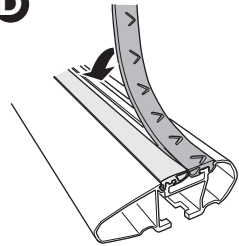

E

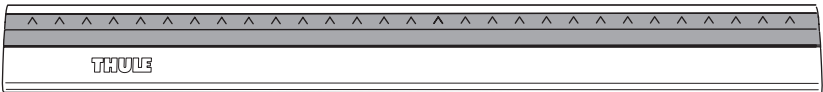
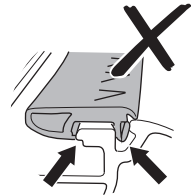
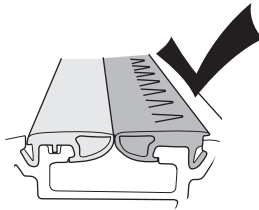
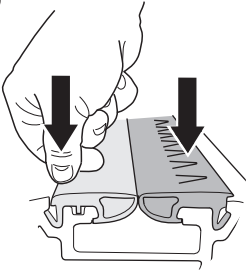

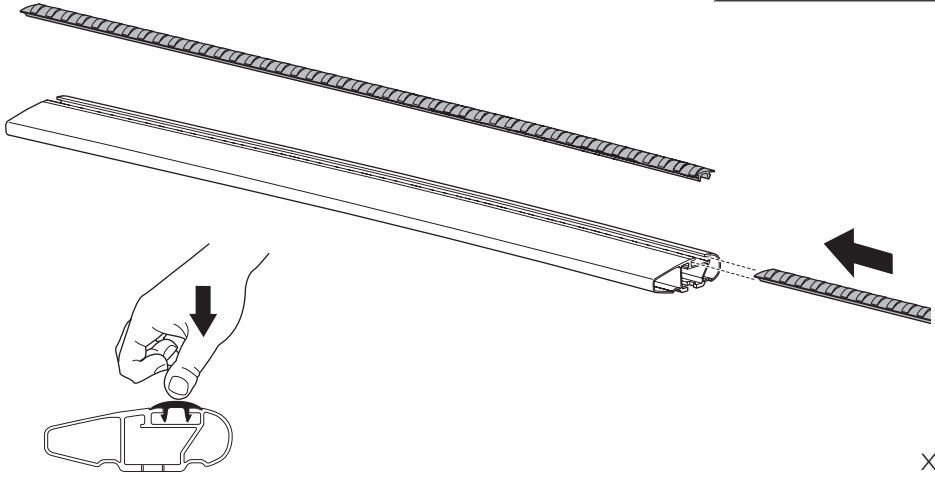

2



A

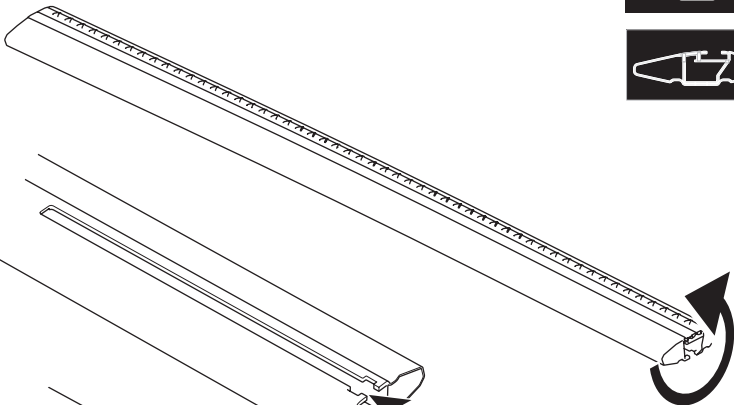

B

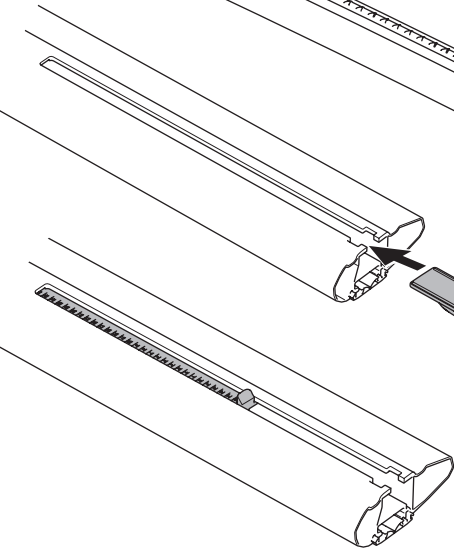

C

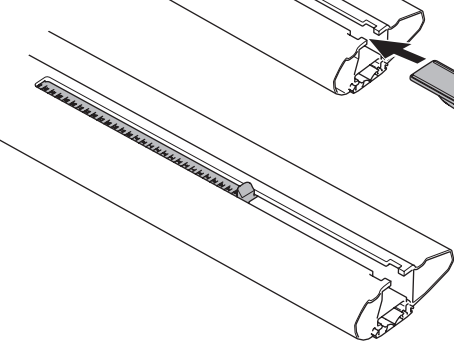

x4

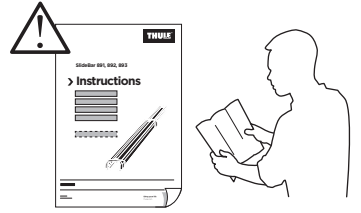
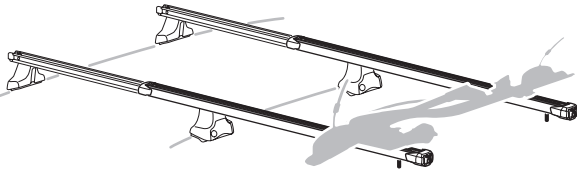

4

A

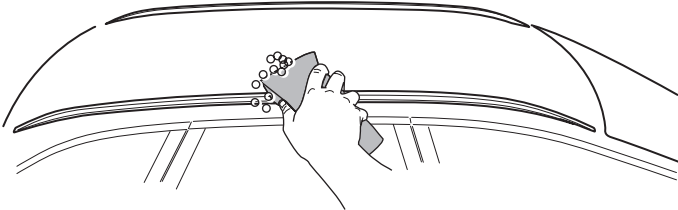

B

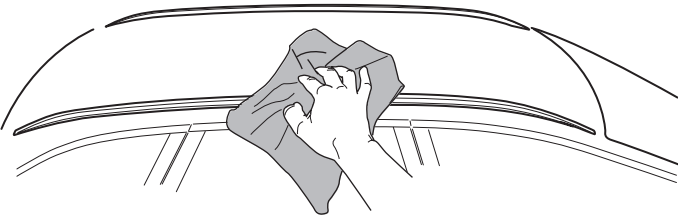

5

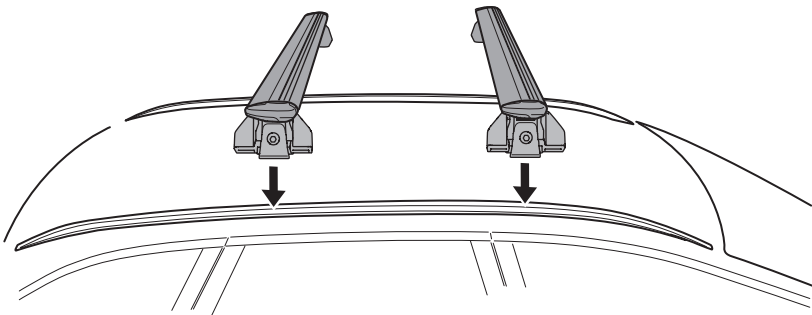
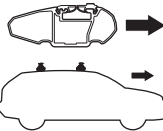

6

~ 700 mm

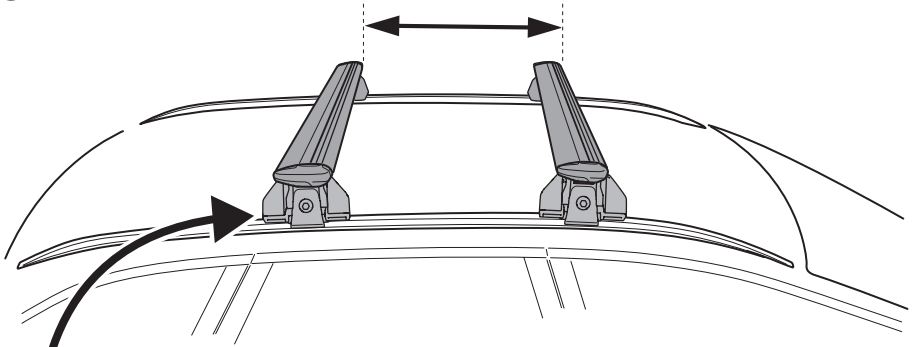

1

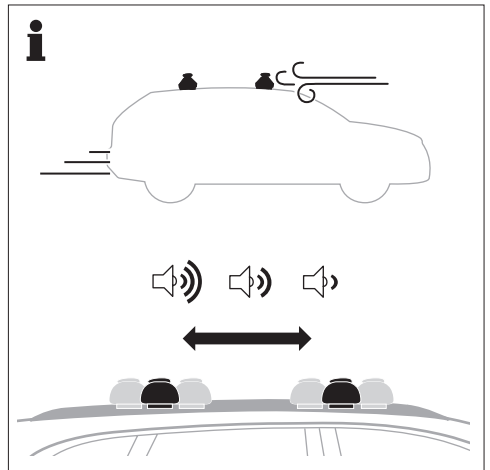
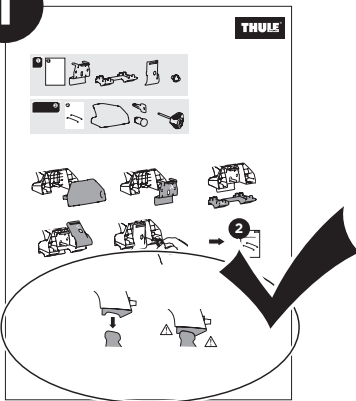

7

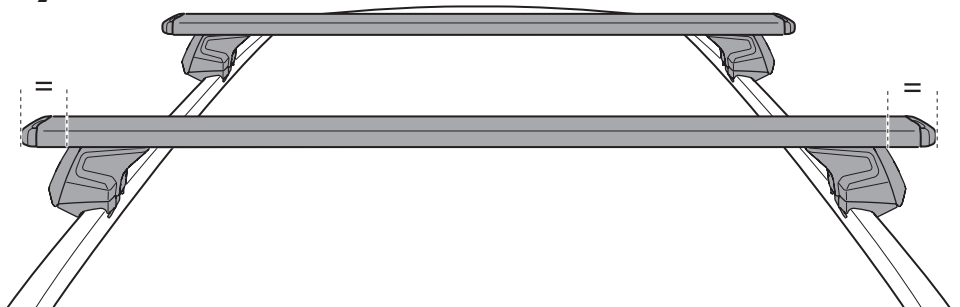

8

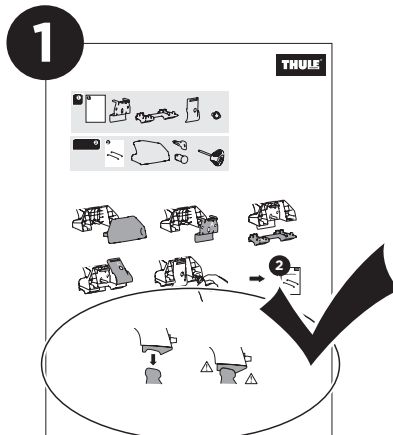
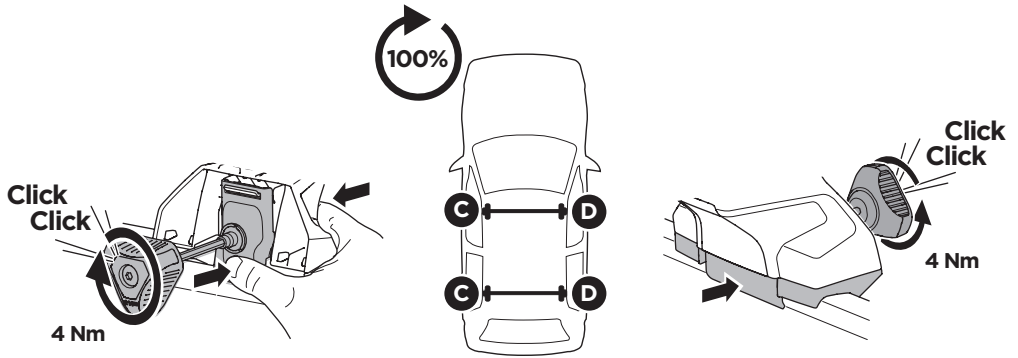
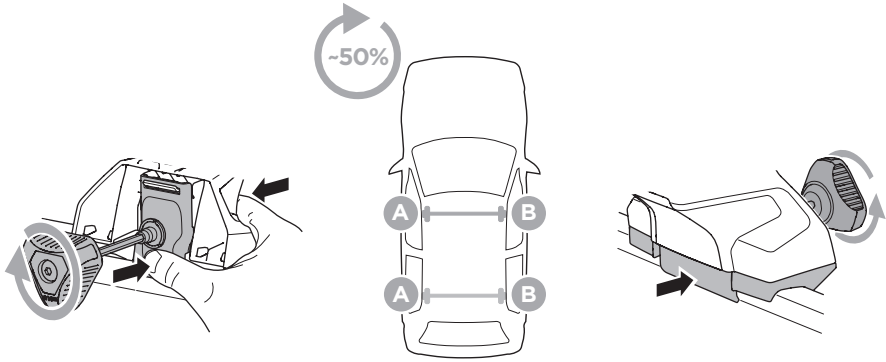

9

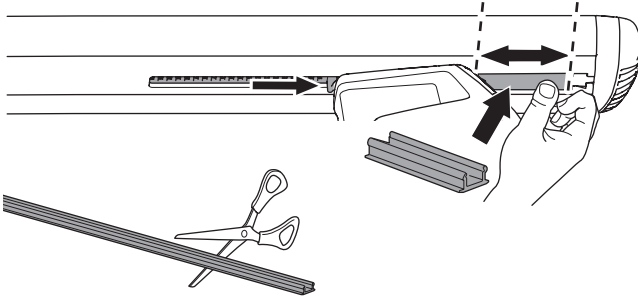

x4

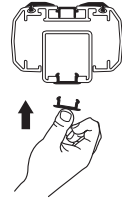
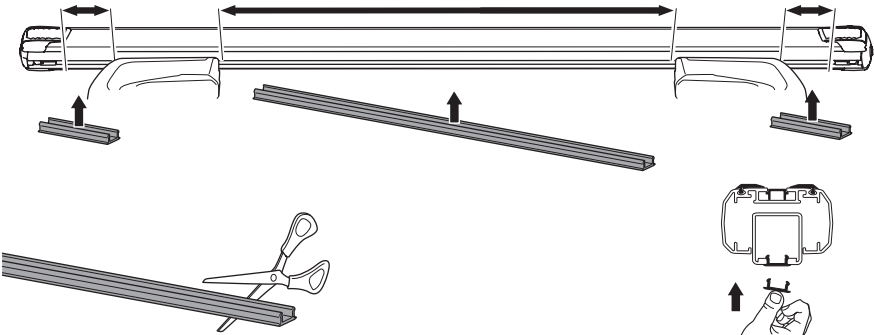

x2

17 mm

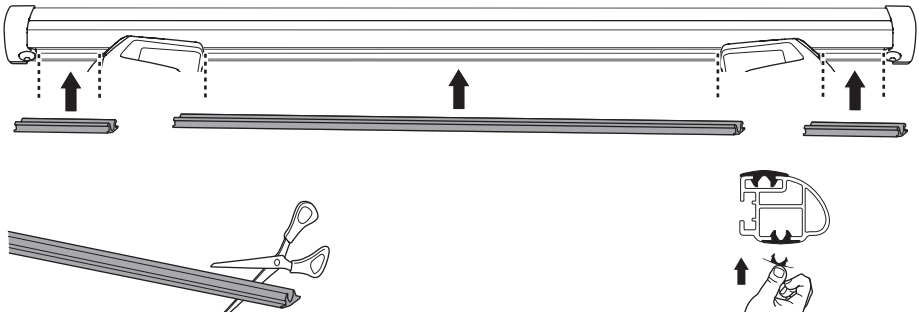
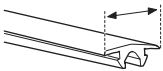

x2

10

A

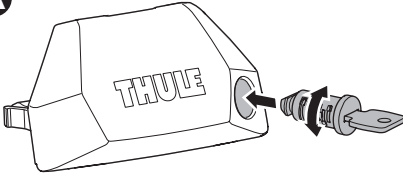

B

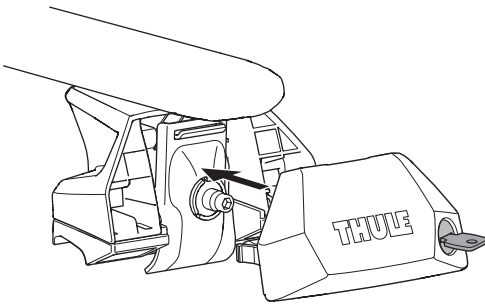

C

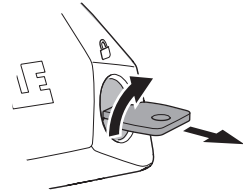

x4

11

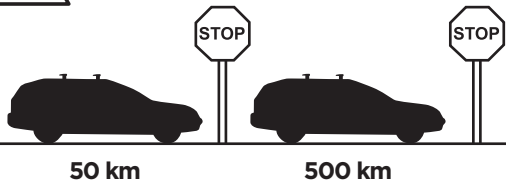
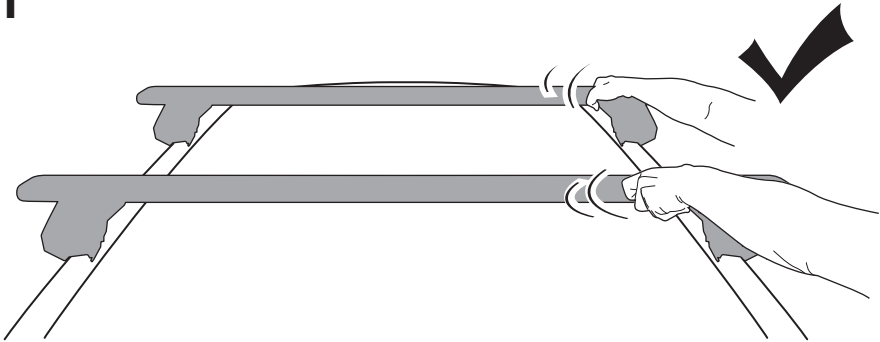

50 km

500 km

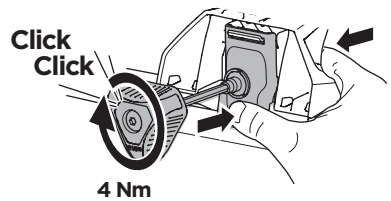

4 Nm

i

